

Activation Modes

Any questions? Call us on 01246 450789

The monitor can be activated by plugging a pressure mat into the lead, sound activation or both.

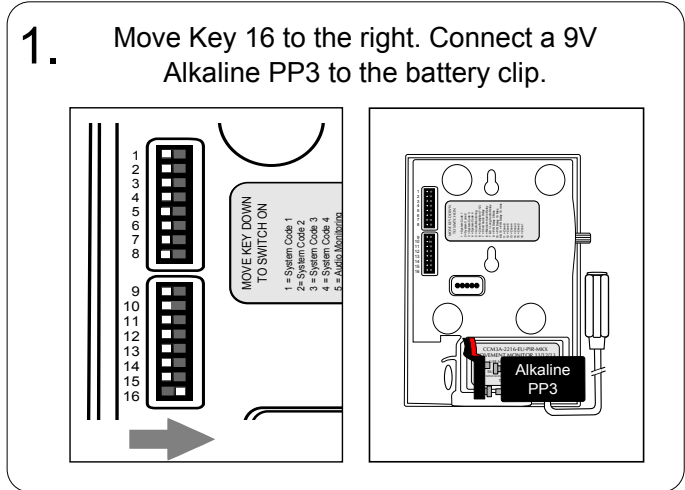
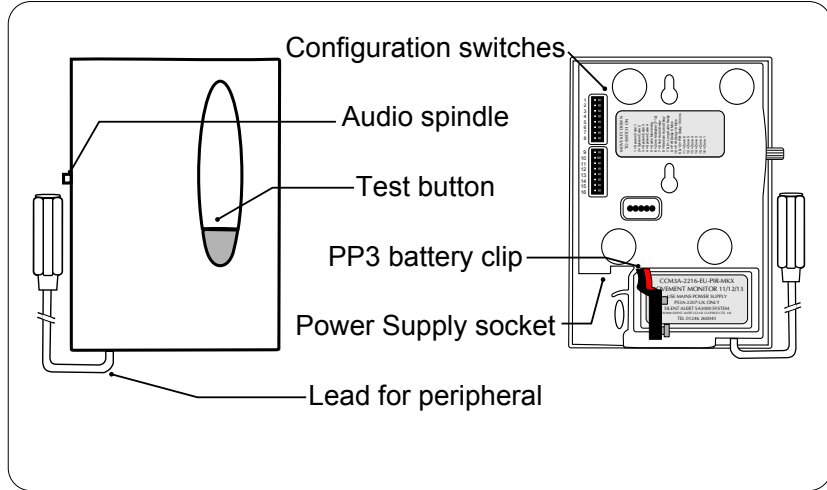

Peripheral activation

The Universal Monitor is compatible with the PM2 pressure mat, PM5 chair mat and the Jelly bean twist switch.

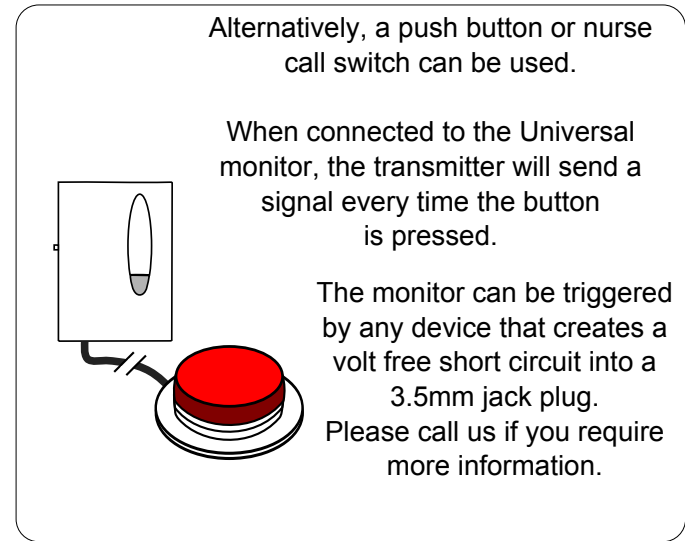
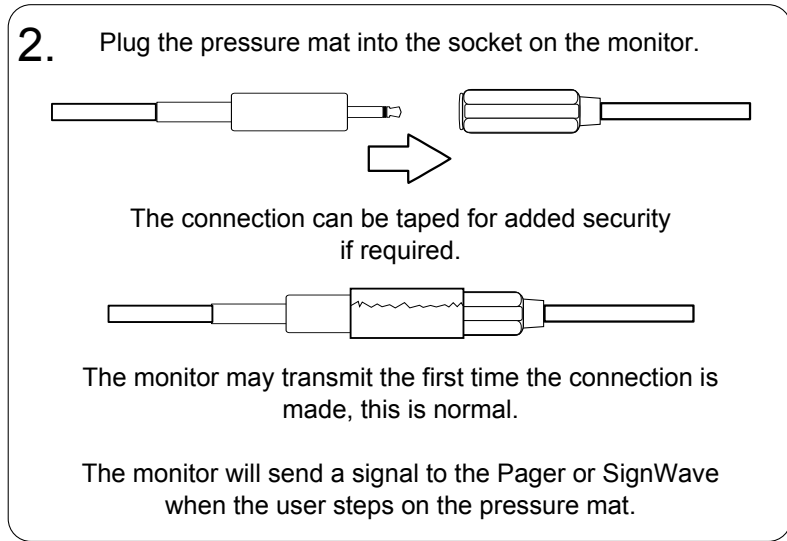

Sound Activation

It is possible to enable sound monitoring as well as peripheral activation. Audio trigger delays can be used to reduce false alarms from transient noise (door slams etc).

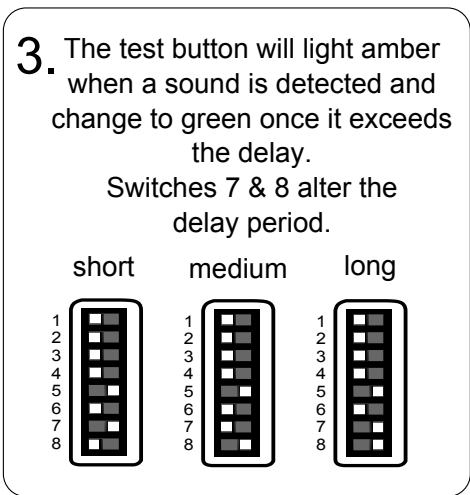
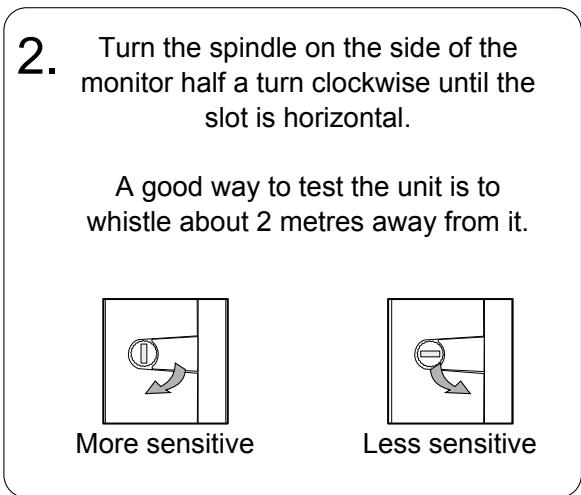
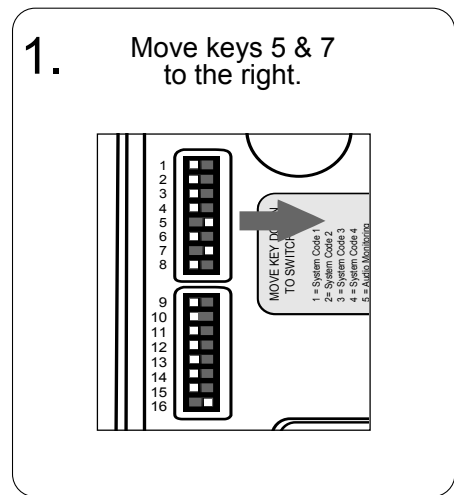

Advanced Settings CCM3A-2214-EU-LEAD

Care Call universal monitor with lead



Any questions? Call us 01246 450789

Zone Setting

The monitor can be coded to light any one of twelve zones on the Pager or SignWave. The diagram below shows the relevant key settings for zones one to six.

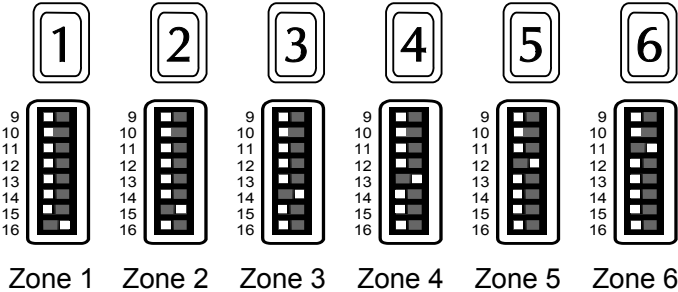

Zones seven to twelve are displayed using a numbered key together with the battery key (+6).

To enable this feature, on the monitor move key 9 and one of the zone keys to the right.

Zone 7 is therefore shown as zone 1 + the battery key.

Zone 8 is shown as zone 2 + the battery key and so on.

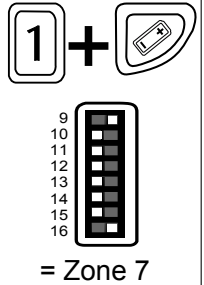

Changing the system channel code

NOTE: In most cases it is not necessary to change the system code. However, when one or more systems are in close proximity, system codes can be used to avoid interference from other Care Call systems using up to a maximum of 16 channels.

The monitor is supplied with no system code switches set (system code 1). For reference this is the factory setting should you need to re-set the unit.

System codes can be set using key switches 1 - 4.

The diagram to the right shows the 16 possible combinations.

Be sure that the same system code is set on the receiver to be used and any other monitoring options in that system.

